

Qty.	Description
1	<b>CM 3-5 A-R-A-E-AVBE F-A-A-N</b>
	
	<b>Note! Product picture may differ from actual product</b>
	Product No.: On request
	<p>Compact, reliable, horizontal, multistage, end-suction centrifugal pump with axial suction port and radial discharge port. The shaft, impellers and chambers are made of stainless steel. The inlet and discharge parts are made of cast iron. The mechanical shaft seal is a special designed, unbalanced O-ring seal. Pipework connection is via internal Whitworth pipe threads, Rp (ISO 7/1).</p>
	<p>The pump is fitted with a 3-phase, foot-mounted, fan-cooled asynchronous motor.</p>
	<b>Controls:</b> Frequency converter:                 NONE
	<b>Liquid:</b> Pumped liquid:                         Water Liquid temperature range:         -20 .. 90 °C Selected liquid temperature:       20 °C Density:                                 998.2 kg/m <sup>3</sup>
	<b>Technical:</b> Pump speed on which pump data are based:   2900 rpm Rated flow:                             3.1 m <sup>3</sup> /h Rated head:                             34.75 m Code for shaft seal:                 AVBE Approvals:                             CE,EAC,UKCA Approvals for drinking water:       ACS,NSF61 Curve tolerance:                     ISO9906:2012 3B
	<b>Materials:</b> Pump housing:                         Cast iron EN-GJL-200 ASTM A48-25A Impeller:                               Stainless steel EN 1.4301 AISI 304
	<b>Installation:</b> Range of ambient temperature:     -20 .. 55 °C Maximum operating pressure:       10 bar Max pressure at stated temp:       10 bar / 40 °C 6 bar / 90 °C
	<b>Type of connection:</b> Rp Size of inlet connection:            1 inch Size of outlet connection:           1 inch Outlet position:                       12
	<b>Electrical data:</b> Motor standard:                     IEC Frame size:                           71B IE efficiency class:                 IE2 Rated power - P2:                   0.6 kW Mains frequency:                    50 Hz Suitable for 50/60 Hz:               N Rated voltage:                        3 x 220-240D/380-415Y V Service factor:                       1.00

Qty.	Description
1	<p>Rated current: 2,8-3,1/1,6-1,8 A  Starting current: 580-500 %  Rated speed: 2810-2850 rpm  Enclosure class (IEC 34-5): IP55  Insulation class (IEC 85): F  Built-in motor protection: NONE  Cable included (Yes/No): N</p> <p>Others:  Terminal box position: 12  Minimum efficiency index, MEI ≥: 0.7  Net weight: 12.5 kg  Gross weight: 15 kg  Country of origin: TW  Custom tariff no.: 84137042</p>

# On request CM 3-5 A-R-A-E-AVBE F-A-A-N 50 Hz

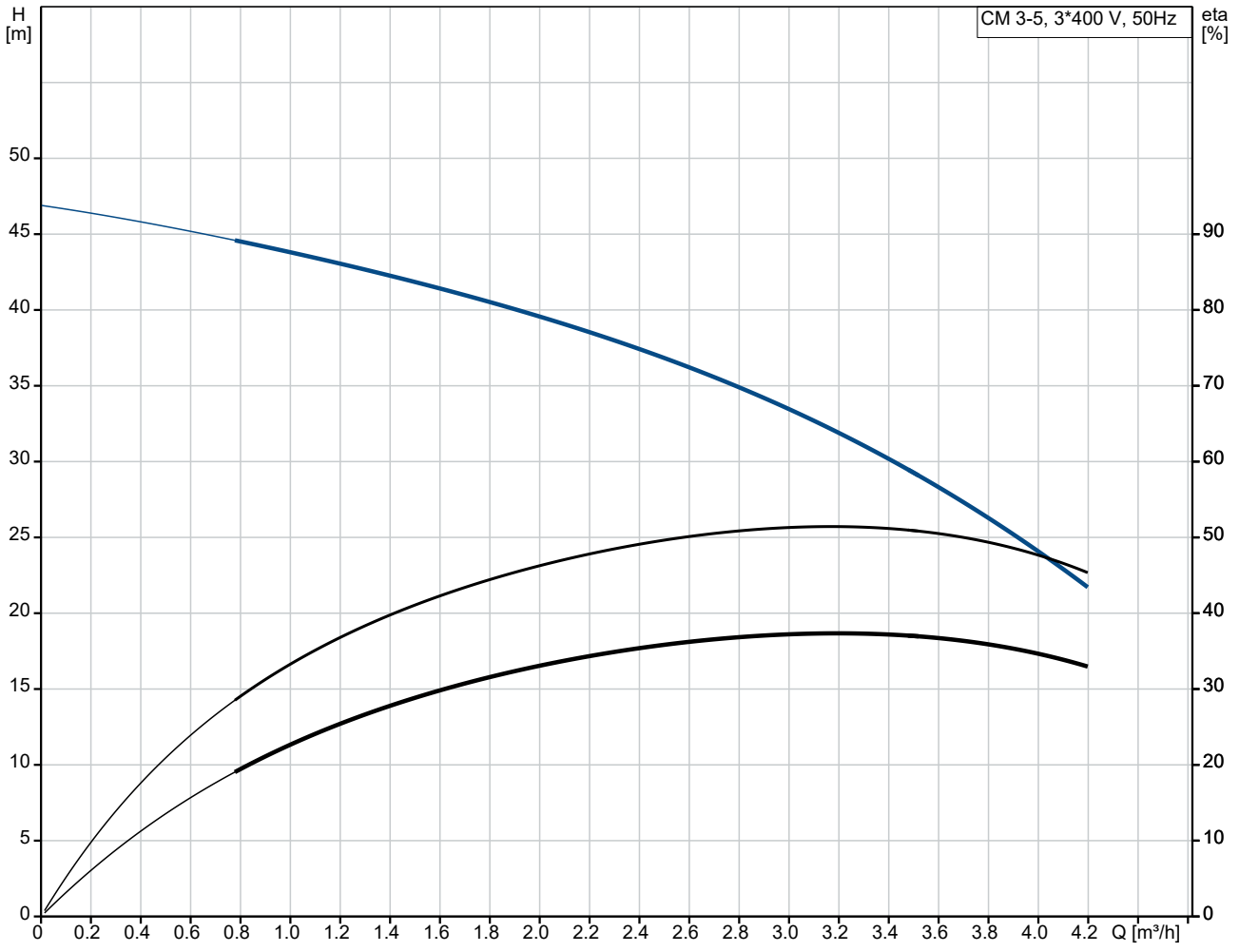

Pumped liquid = Water  
 Liquid temperature during operation = 20 °C  
 Density = 998.2 kg/m³

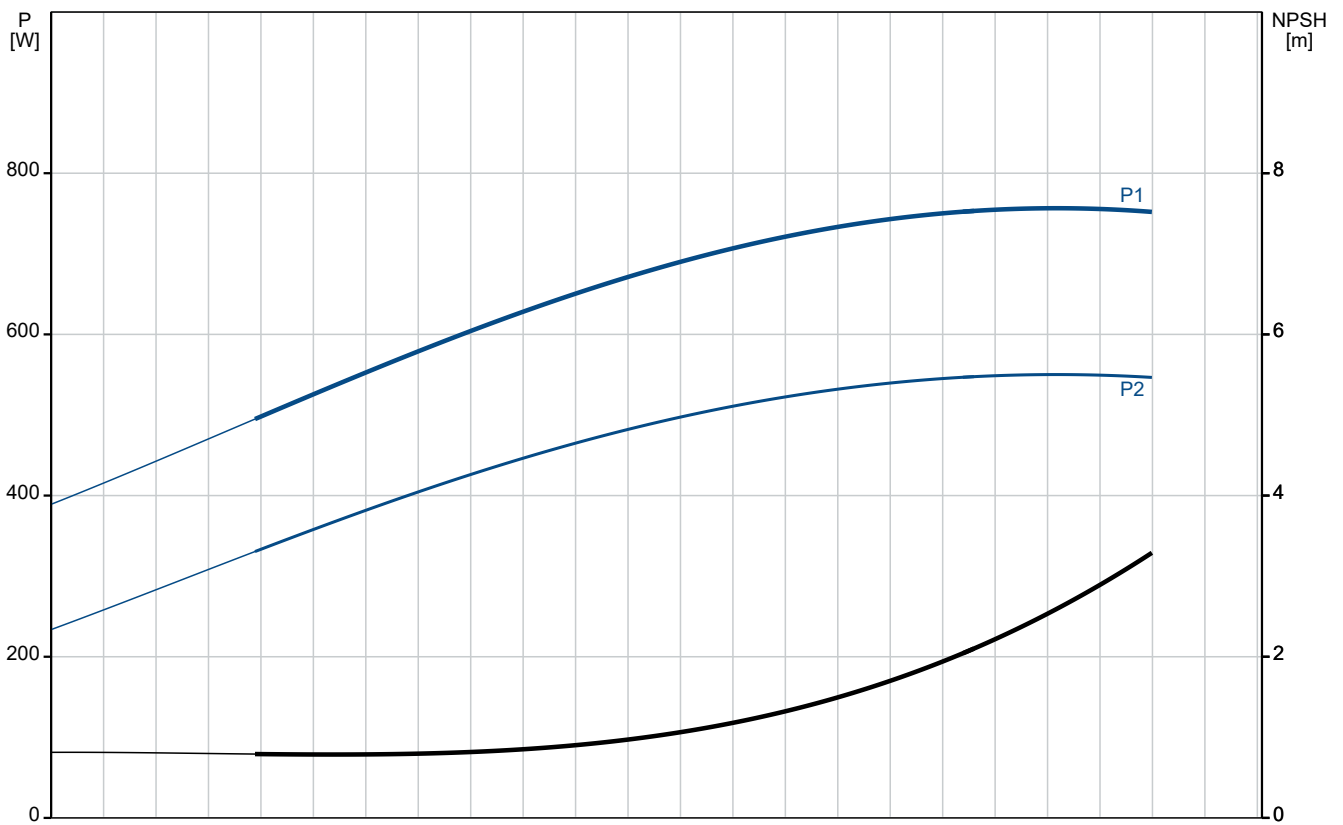

Description	Value
<b>General information:</b>	
Product name:	CM 3-5 A-R-A-E-AVBE F-A-A-N
Product No:	On request
EAN number:	On request
<b>Technical:</b>	
Pump speed on which pump data are based:	2900 rpm
Rated flow:	3.1 m <sup>3</sup> /h
Rated head:	34.75 m
Impellers:	5
Code for shaft seal:	AVBE
Approvals:	CE,EAC,UKCA
Approvals for drinking water:	ACS,NSF61
Curve tolerance:	ISO9906:2012 3B
Pump version:	A
Model:	A
<b>Materials:</b>	
Pump housing:	Cast iron
Pump housing:	EN-GJL-200
Pump housing:	ASTM A48-25A
Impeller:	Stainless steel
Impeller:	EN 1.4301
Impeller:	AISI 304
Material code:	A
Code for rubber:	E
<b>Installation:</b>	
Range of ambient temperature:	-20 .. 55 °C
Maximum operating pressure:	10 bar
Max pressure at stated temp:	10 bar / 40 °C
Max pressure at stated temp:	6 bar / 90 °C
Type of connection:	Rp
Size of inlet connection:	1 inch
Size of outlet connection:	1 inch
Outlet position:	12
Connect code:	R
<b>Liquid:</b>	
Pumped liquid:	Water
Liquid temperature range:	-20 .. 90 °C
Selected liquid temperature:	20 °C
Density:	998.2 kg/m <sup>3</sup>
<b>Electrical data:</b>	
Motor standard:	IEC
Frame size:	71B
IE efficiency class:	IE2
Rated power - P2:	0.6 kW
Mains frequency:	50 Hz
Suitable for 50/60 Hz:	N
Rated voltage:	3 x 220-240D/380-415Y V
Service factor:	1.00
Rated current:	2,8-3,1/1,6-1,8 A
Starting current:	580-500 %
Rated speed:	2810-2850 rpm
Enclosure class (IEC 34-5):	IP55
Insulation class (IEC 85):	F
Built-in motor protection:	NONE
Cable included (Yes/No):	N
<b>Controls:</b>	
Frequency converter:	NONE
<b>Others:</b>	
Terminal box position:	12
Minimum efficiency index, MEI ≥:	0.7
Net weight:	12.5 kg
Gross weight:	15 kg

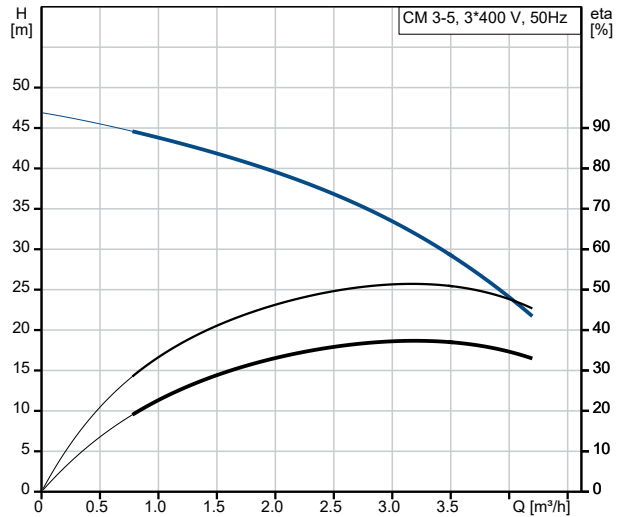

Pumped liquid = Water  
Liquid temperature during operation = 20 °C  
Density = 998.2 kg/m<sup>3</sup>

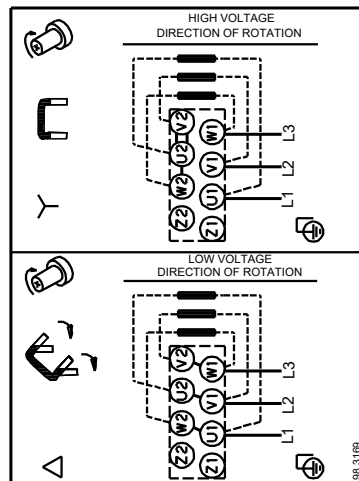
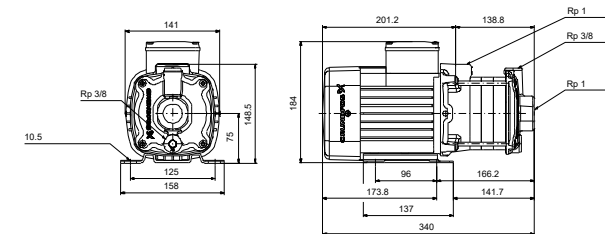
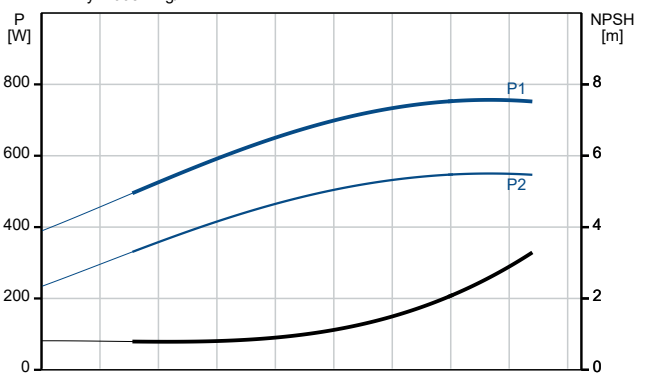

Description	Value
Country of origin:	TW
Custom tariff no.:	84137042

# On request CM 3-5 A-R-A-E-AVBE F-A-A-N 50 Hz

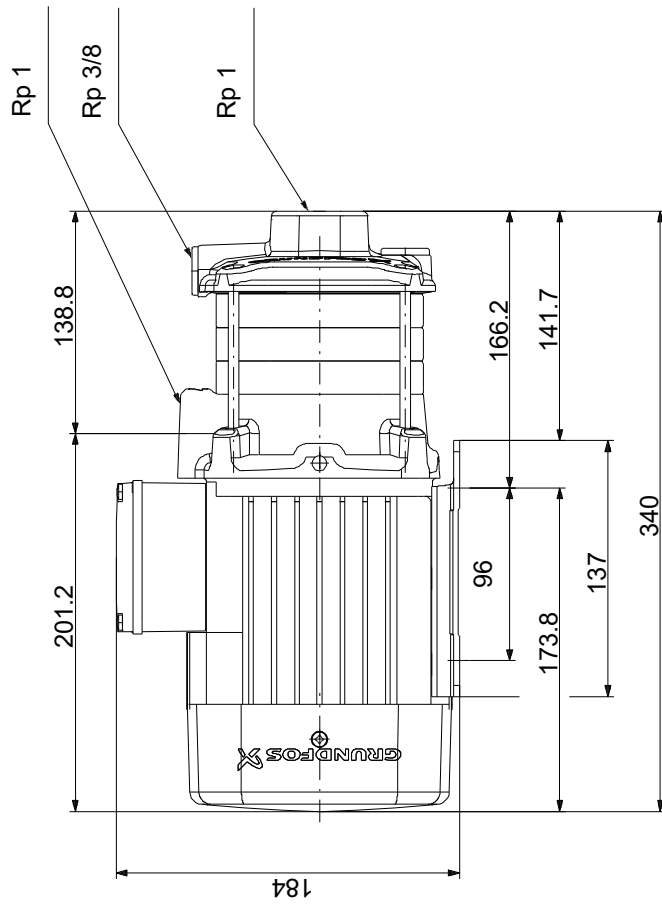

Note! All units are in [mm] unless others are stated.  
 Disclaimer: This simplified dimensional drawing does not show all details.